



Installation & Maintenance Guide



Midea Heat Pump Water Heater - 170 Litre

WARNING

This unit requires reliable earthing before usage, otherwise this may result in injury or death.



If you can't ensure that the property's power supply is correctly earthed, please don't install the unit.

The unit must be installed by a licensed trade person and in accordance with:

- This Installation & Maintenance Guide.
- AS/NZS 3500.4 - "National Plumbing and Drainage Code Hot Water Supply Systems-Acceptable Solutions".
- AS/NZS 3000-Wiring Rules.
- Local authority regulations.
- Building Codes of Australia.
- Local Occupational Health and Safety (OH&S) Regulations.

NOTICE TO CUSTOMERS

This water heater must be installed by a licensed person as required by the Building Act. Only a licensed person will give you a certificate of compliance, showing that the work complies with all the relevant standards and only a licensed person will have insurance protecting their workmanship.

Please read and understand this booklet. If you have any questions, please contact our service team on 1300 367 565.

WARNING - HOT WATER CAN BE DANGEROUS

Hot water burns! As a safety precaution, young children should always be supervised around hot water fixtures.

Heat pump water heaters can store water at temperatures that can cause scalding. Water temperatures over 50°C can scald and care needs to be taken to ensure that injuries do not occur through incorrect use of your water heater.

As heat pump water heaters can generate water temperatures in excess of 50°C, regulations require that a tempering valve be fitted to the heater to prevent water temperatures going to the home exceeding a pre-set safe maximum. A tempering valve must be connected to the hot water outlet line from the water heater. The valve must be fitted by an authorised plumber at the time of installation or in retrofitting to existing systems.

Care should be taken to avoid coming into contact with any pipe work or fixtures associated with the water heater pipe lines. Under NO circumstances should any 'home handy man' type modifications be attempted.

- This appliance is not intended for use by persons (including children) with reduced physical sensory or mental capabilities, or lack of experience and knowledge, that prevents them from using the appliance safely without supervision or instruction. Children should be supervised by a responsible person for their safety to ensure that they do not play with the appliance.
- **DANGER:** Failure to operate the relief valve easing gear at least once every six months may result in the water heater exploding. Continuous leakage of water from the valve may indicate a problem with the water heater.
- **THE INSTALLATION MUST COMPLY WITH THE REQUIREMENTS OF AS/NZS 3500.4, AS/NZS 3000, and all local codes and regulatory authority requirements. In New Zealand, the installation must conform to the New Zealand Building Code G12.**

The power supply must be protected by an individual circuit breaker at the main electrical supply switchboard and rated to suit the size of the element. The supply to the heat pump water heater can be operated directly from the switchboard or via a remotely mounted switch as requested by the customer. The heater must be provided with a suitable means for disconnecting the power supply.

GUIDE CONTENTS

Section 1: Product Information & Schematics	1-2
Section 2: Safety Information	3
Section 3: Before Installation	4
Section 4: System Installation	5-8
Section 5: System Commissioning	9-10
Section 6: System Operation	11-14
Section 7: System Troubleshooting	15-17
Section 8: System Maintenance	18
Section 9: Warranty	19

1 | PRODUCT INFORMATION & SCHEMATICS

1.1 System Schematics (Dimensions in millimetres)

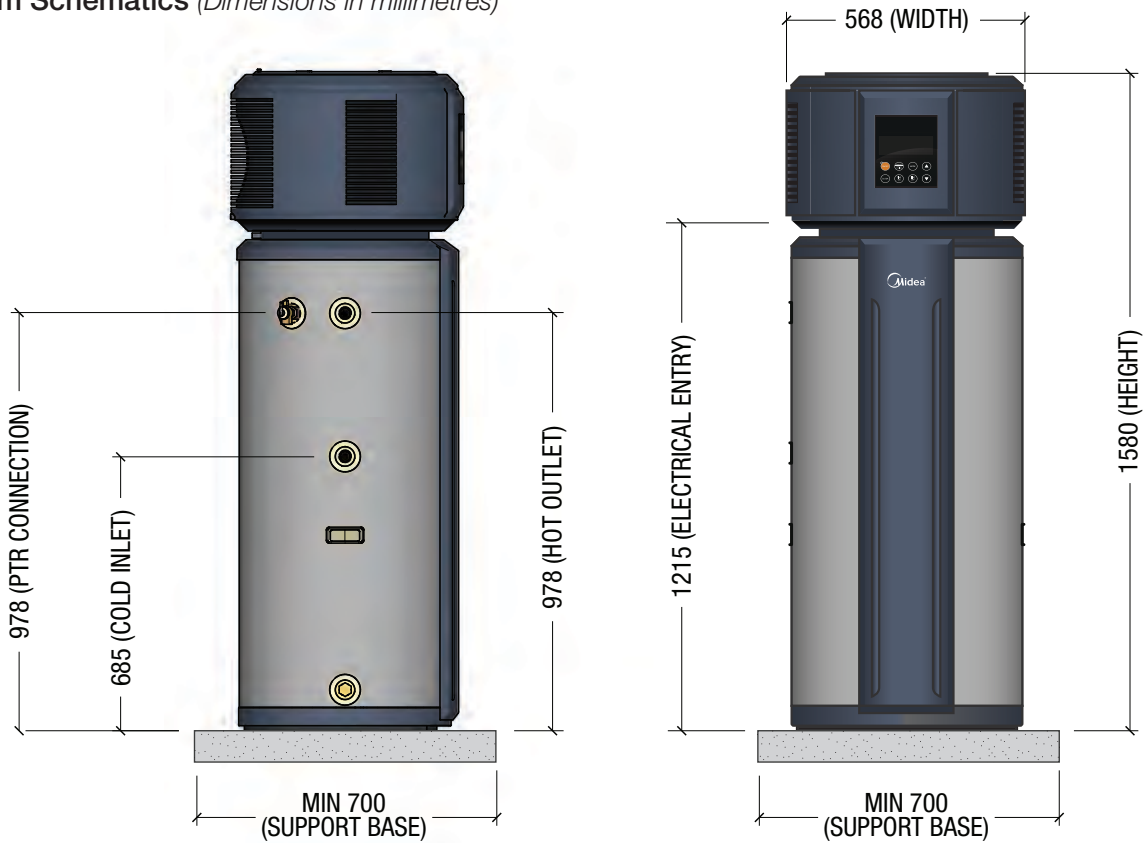

1.2 System Parts

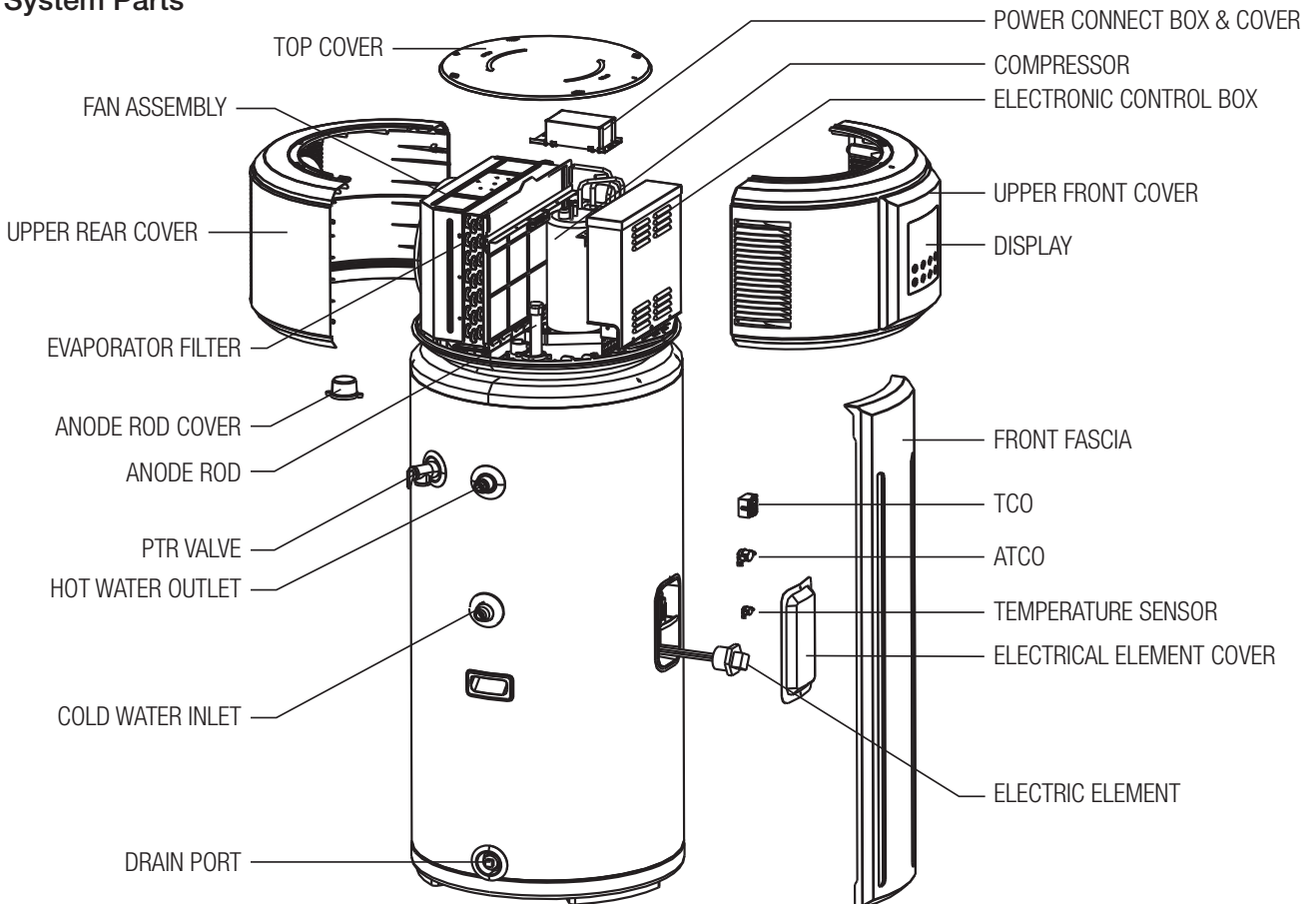

NOTE

All pictures in this manual are for explanation purpose only. They may differ from the actual unit.

1.3 System Specifications

Model	HP170 (RSJ-15/190RDN3-C)			
Modes	Economy	Hybrid		E-Heater
Hot water heating capacity	1500W	Heat Pump 1500W	E-Heater 2150W	2150W
Rated input power/current	780W/3.4A	2780W/12.1A		2150W/9.3A
Power supply	220-240V~ 50Hz			
Protection	Over-load Protector, Temp Controller & Protector, Electric Leakage Protector			
Compressor power / E-heater power	440W / 2150W			
Water pipeline system	Outlet water temperature	Default 60°, (60°-70° adjustable)		
	Water side exchanger	Outer coil inner water tank		
	Inlet / Outlet connector diameter	DN20		
	Drain connector diameter	DN20		
	PTR valve connector diameter	DN20		
Exchanger air Side	Material	Hydrophilic aluminium fin, inner groove copper tube		
	Motor power	40W		
	Air inlet / outlet	Air in from Sides / Air out from Rear		
Fusible link type	T20A 250VAC			
Refrigerant	R134a (800g)			
Dimension	Ø568x1580mm			
Water tank capacity	170L			
Net weight	90kg			

The test conditions: 1. Test temperature 15/12°C (DB/WB) / 2. Water temperature from 15°C up to 45°C.

1.4 Electrical Schematic

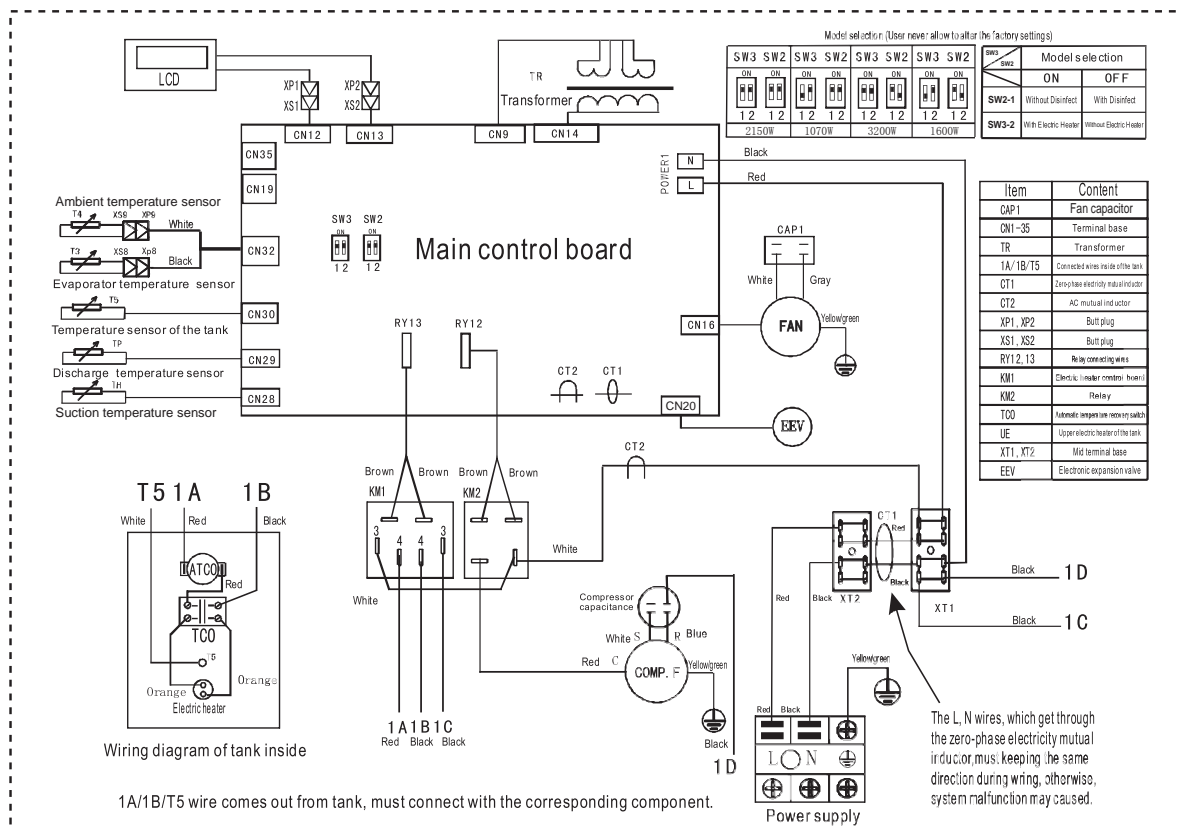

2 | SAFETY INFORMATION

Please read thoroughly all of the instructions before installing and operating the unit.
The following safety warnings are very important, always read and obey all safety symbols:

WARNING

- The unit must be earthed effectively.
- A RCD breaker must be installed adjacent to the power supply.
- Do not remove, cover or deface any permanent instructions or labels from either the outside or inside of the unit panels.
- Only qualified persons should install the unit in accordance with local and national regulations and this guide.
- Improper installation may result in water leakage, electric shock or fire.
- All electric connections should comply with the regulations of the local power company, local electric utility and this guide.
- Never use an incorrectly rated fuse, otherwise the unit may break down and cause an electrical fire.
- Do not insert fingers, rods or other objects into the air inlet or outlet. The fan is rotating at high speed, and may cause injury.
- Never use a flammable spray such as hair spray or lacquer paint near the unit. It may cause a fire.
- This appliance is not intended for use by persons (including children) with reduced physical, sensory or mental capabilities, or lack of experience and knowledge, unless they have been given supervision or instruction concerning use of the unit by a person responsible for their safety. Children should be supervised to ensure that they do not play with the appliance.
- **DISPOSAL:** Do not dispose of electrical appliances as unsorted municipal waste, use separate collection facilities. Contact your local government for information regarding the collection systems available.
- If electrical appliances are disposed of in landfills or dumps, hazardous substances can leak into the groundwater causing health concerns.
- The unit must be securely fixed, otherwise, noise and vibration may result.
- Make sure that there are no obstacle around the unit.
- If the unit is to be installed in an area that is subject to lengthy periods of direct sunlight, additional UV protection for the display screen is advised.
- In places where there are strong winds (e.g. seaside locations), fix the unit in an area protected from the wind.
- The PTR Valve should be operated every 6 month to make sure that there is no restriction of the valve. Please beware of hot water being expelled from the valve. The drainage pipe should be well insulated in order to prevent water inside pipe from freezing in cold weather.

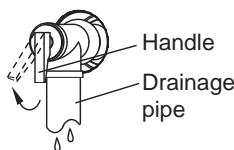

CAUTION







- The earthing pole must be well grounded. Make sure that any power supply socket and plug are dry and connected tightly.
- Before cleaning, be sure to stop the operation and isolate the unit (i.e. turn the isolating switch or breaker off). Otherwise, an electric shock and injury may be caused.
- Water temperature over 50°C can cause severe burns or even death from scalds. Children, disabled and elderly are at highest risk of being scalded. Feel water before bathing or showering. Water temperature limiting valves are required as per AS 3500.
- Do not operate the unit with a wet hand as an electric shock may occur.
- A one-way (non-return) valve must be installed on the water inlet side, as well as a suitable isolation valve.
- It is normal for some water to be released from the PTR valve during operation. But, if there is a large volume of water, call our service team for further advice. After long term use, check the unit base and fittings. If damaged, the unit may sink, resulting in injury. Arrange the drain pipe to ensure effective draining. Improper drainage may cause water damage to surrounding areas such as buildings, furniture etc. Do not touch the inner parts of the controller or remove the front panel. Some parts inside are dangerous to touch, and may cause damage.
- Do not turn off the power supply except for service and maintenance purposes. A continuous power supply for water heating is necessary.
- Hydrogen gas is extremely flammable, and may build up if no water is drawn off for several weeks. To reduce the risk of injury under these conditions, it is recommended that the hot water tap is opened for several minutes at the kitchen sink before using any electrical appliance (i.e. washing machine / dishwasher) connected to the hot water system. When hydrogen is present, there will probably be an unusual sound such as air escaping through the pipe as the water begins to flow. There should be no smoking or open flame near the tap at the time it is open.



3 | BEFORE INSTALLATION

3.1 Unpacking

When unpacking ensure the following items are included:

	Main Unit The Main unit including the storage tank & heat pump
	Fascia Cover A decorative panel to cover the electrical compartments
	Condensation Tube Used for draining condensation from the unit
	PTR Valve Pressure Temperature Relief Valve (May be pre-fitted)
	Installation & Maintenance Guide In-depth installation & maintenance detail on the product
	Quick Start Guide A quick step by step visual look at installation

3.2 Transporting the unit

The following should be adhered to when transporting the unit:

1. Don't incline the unit more than 25° from vertical when moving, and keep it vertical when installing.
2. Avoid scratching or damaging the unit by using protective coverings where applicable.
3. As this unit is heavy it needs to be carried by two or more persons, to avoid injury and/or damage.

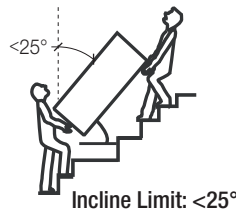

3.3 Location requirements

The following considerations should be addressed when finding a suitable location:

4. Ensure enough space for installation and future maintenance is allowed.
5. Both the air inlets & outlet should be free from obstacles & strong wind.
6. The base surface should be flat (i.e. no more than a 2° incline) and be able to bear the weight (over 285kg) whilst ensuring no issue will arise in regards to increased noise and/or vibration.
7. Operating noise & air flow expelled should not affect others.
8. Ensure no flammable gas is nearby.
9. Positioning should be convenient for plumbing and wiring.
10. Installing indoors may cause indoor temperature fluctuations and excessive noise.
11. If the unit has to be installed on a metal part of the building, make sure the electrical insulation meets the relevant local standard.
12. Securely fixing the unit will assist in avoiding unwanted noise and/or vibration.

⚠ CAUTION

- Consideration must also be made in regards to the ambient air temperature. Heat pump economy mode operates between ambient air temperatures of 5°C and 43°C. Temperatures below this range will rely purely on the electrical element and the heat pump economy mode will not operate.
- The unit should be located in an area not subject to freezing temperatures. A unit located in unconditioned spaces (i.e. garages, basements, etc.) may require the condensate tubing, and drain piping to be insulated against freezing.

Installing the unit in any of the following places may lead to malfunction (*consult with your representative prior to purchase*).

- Site contains mineral oils (e.g. lubricant of cutting machines).
- Seaside areas or where the air contains salt.
- Hot spring areas where corrosive gases exist (e.g. sulphide).
- Factories where the power voltage fluctuates dramatically.
- Inside a recreational vehicle (RV) or cabin.
- Places with direct sunlight and/or other high heat sources. (If there's no way to avoid these, a cover may be required).
- Areas where oil may permeate the system (e.g. Kitchens).
- Areas where strong electromagnetic fields exist.
- Areas where flammable gases or materials exist.
- Areas where acidic or alkaline gases exist.
- Other special environments.

3.4 If installed in enclosed space

If the unit is installed in an enclosed space the area must be greater than 15m³, and must have unrestricted air flow. As an example, a room that has a 2.5 metre tall ceiling and is 3 metres long by 2 metres wide would contain 15m³.

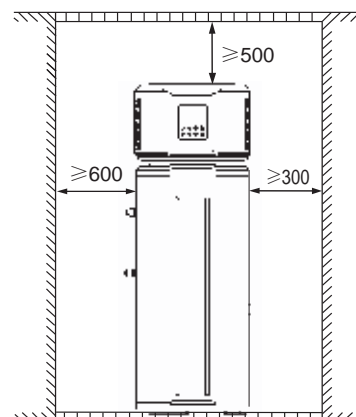
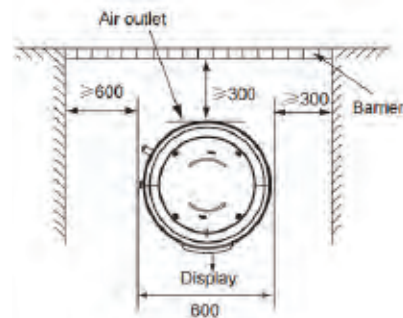

4 | SYSTEM INSTALLATION

4.1 Plumbing Layout

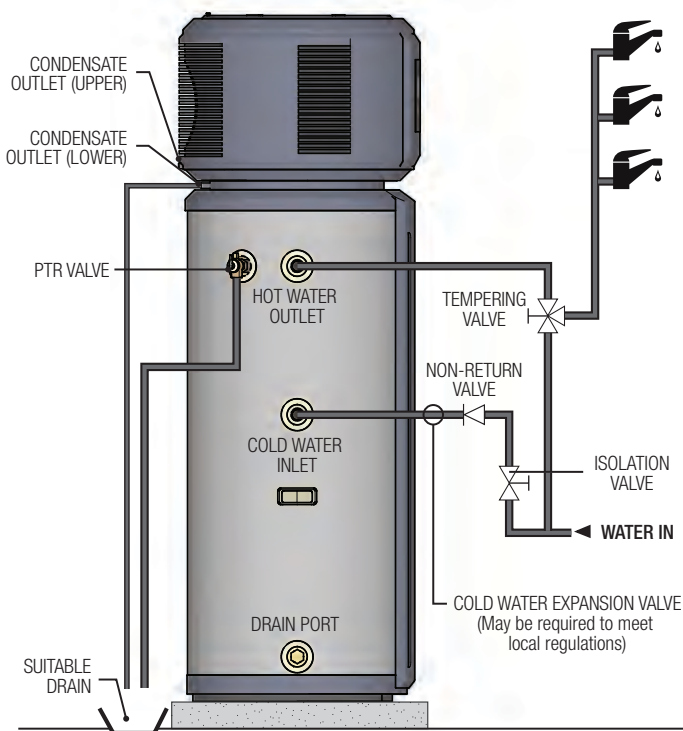

NOTE

- The cold water inlet and hot water outlet are 3/4" (20mm) male (external thread) connections.
- The PTR outlet is a 3/4" (20mm) female (internal thread) connection.
- The Drain port is a 3/4" (20mm) female (internal thread) connection.
- All hot water plumbing must be insulated for safety & heat retention.
- The circulating air for every unit should be more than 350m³/h. Make sure there is enough installation space. Refer dimensional drawing (see page 4).

CAUTION

- Systems must be plumbed as per the above figure. In case of installing where outside temperatures fall below 5°C, insulation must be provided for hydraulic components (i.e. piping).
- If the inlet water pressure is less than 150kPa, a pump should be installed at the water inlet.
- To guarantee the safe usage of tank, a reduction valve should be installed in the water inlet line if the water pressure exceeds 500kPa.
- Pipes must be heat-resistant and durable.

WARNING

- Do not dismantle the PTR Valve,
- Do not block off the Drainage pipe, it may cause explosion and/or injury.



4.2 Installation position requirement

Install the unit with suitable clearance for air flow and plumbing access (refer to options below)

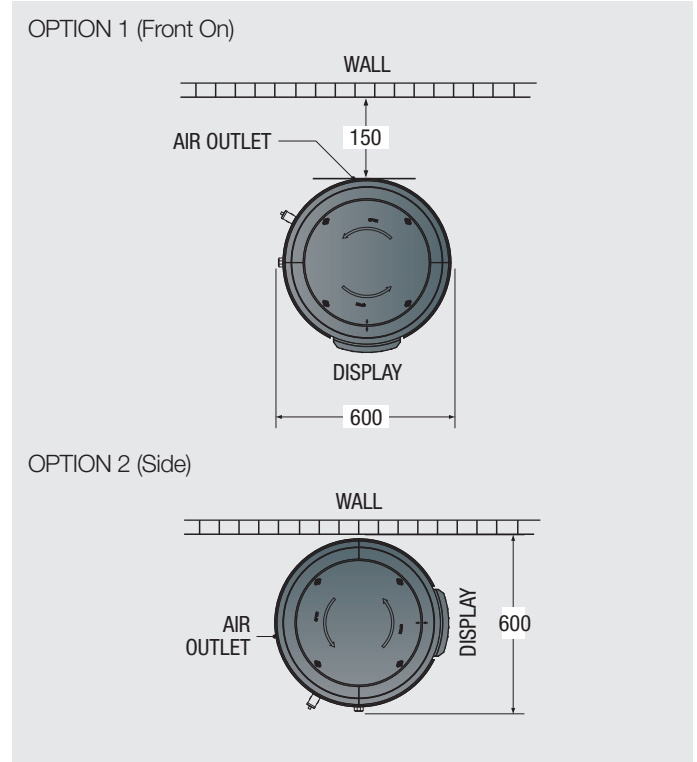

Position the unit on a flat sturdy surface able to bear the weight of a fully filled unit (allow over 285kg).

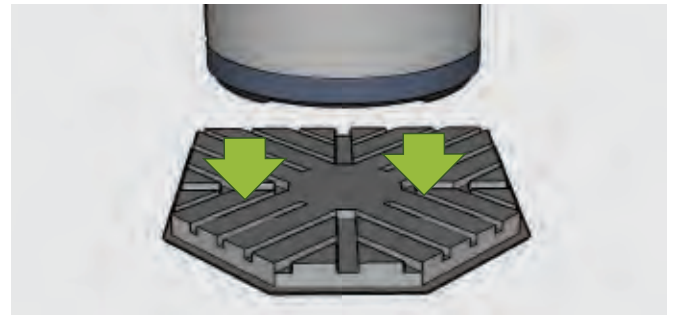

To ensure correct drainage of condensation from the unit, please install on a level base. If the base is not level please ensure the drain location is positioned towards the lower end. Maximum inclination angle of unit relative to the ground is 2°.

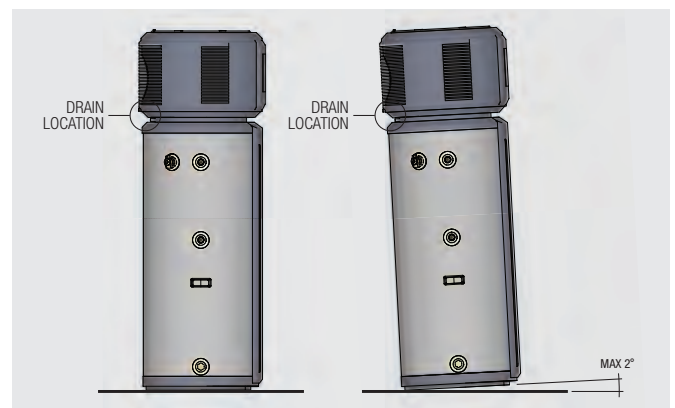

4.3 Plumbing Connections

4.3.1 Condensation draining tube

Fit the condensation tube to the lower port on the rear of the unit and run to suitable location.



4.3.2 Cold water inlet connection

Connect the cold water line to the cold water inlet position, ensuring a suitable isolation and non-return valve is included inline.



4.3.3 Hot water outlet connection

Connect the hot water out line to the hot water outlet position.

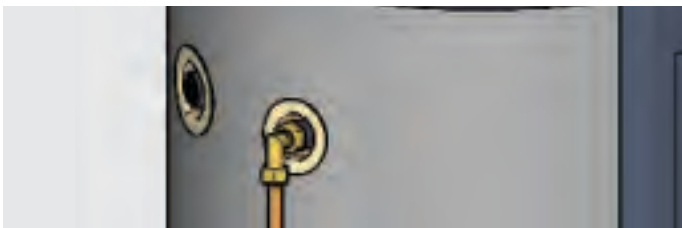

4.3.3 Pressure temperature relief connection

Connect the pressure temperature relief valve (PTR) and suitably drain to legal point of discharge

After installation, it must be confirmed that the drainpipe outlet has a suitable air gap

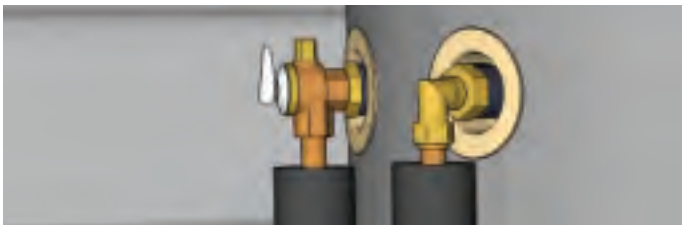

4.3.4 Tempering Valve connections

Plumb a suitable tempering valve between the hot water outlet and the hot water line to the home.

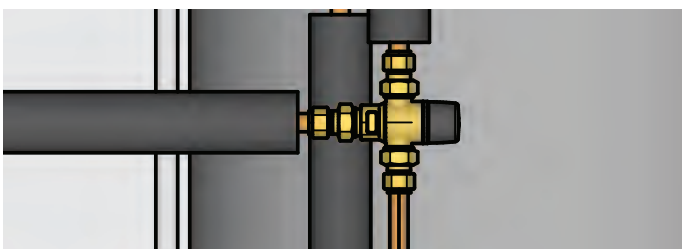

4.4 Electric Connection

Remove the top cover by releasing the locking screw and rotating the cover in a clockwise direction. Then simply lift up to remove.



Wire electrics by feeding the cable through one of the openings on the under face of the upper section of the unit and up to the electrical compartment. Remove the electrical compartment cover by releasing the two screws. Then connect the wires accordingly. (Where possible terminate the electrical connection with a suitable isolating switch (By authorised electrician)

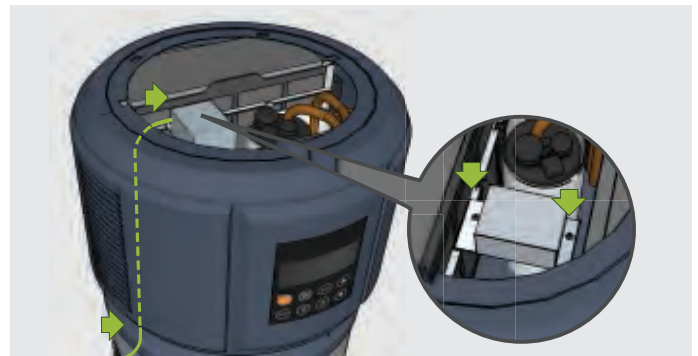

Reposition the top cover and rotate in a counter-clockwise direction to lock. Secure with previously removed screw.



- Set the electric leakage protector according to the relevant electric technical standards of local regulations.
- All electrical works shall be properly run using suitable conduit / insulation without contacting any of the piping or valves.

For further detail please refer to main electrical layout on page 2

⚠ WARNING

The unit must be installed with an RCD near the power supply and must be effectively earthed.

4.4 Protective Covers

4.4.1 Fascia Cover

Fit the fascia cover using the locating pins at the top & the locking bracket at the lower position.



4.4.2 Screen Protection

If the unit is to be installed in an area that is subject to lengthy periods of direct sunlight, additional UV protection for the display screen is advised.

4.5 Installation checklist

4.5.1 Location

- The flooring beneath the water heater is able to support the weight of the water heater when filled.
- Sufficient room has been allowed to service the water heater.
- Sufficient air is available for the heat pump to function (i.e. the unit is not fitted into any type of closet or small enclosure but is located in a space greater than 15m³ with no restrictions to air flow).
- The location is free from any corrosive elements in the atmosphere such as sulphur, fluorine, and chlorine (i.e. elements found in aerosol sprays, detergents, bleaches, cleaning solvents, air fresheners, paint, varnish removers, refrigerants, and many other commercial and household products).
- The location is free from any excessive dust (if so more frequent cleaning will be required by the user).

4.5.2 Water System Piping

- PTR valve (Temperature and pressure relief valve) is properly installed with a discharge pipe plumbed to suitable drain.
- All piping is properly installed and free of leaks.
- The unit is completely filled with water.
- The tempering valve has been installed per manufacturer's instructions.
- The condensate drain line is installed and plumbed to suitable drain.
- All hot water lines are appropriately insulated.

4.5.3 Electrical Connections

- The water heater is connected to 220~240 VAC.
- All wiring sizes and connections comply with all local applicable codes and the requirements of this guide.
- The water heater and electrical supply are properly grounded.
- A correctly sized overload fuse or circuit breaker protection has been installed.

4.6 Final Installation

Below is an example of a proper heat pump installation along with all plumbing and electrical connections.

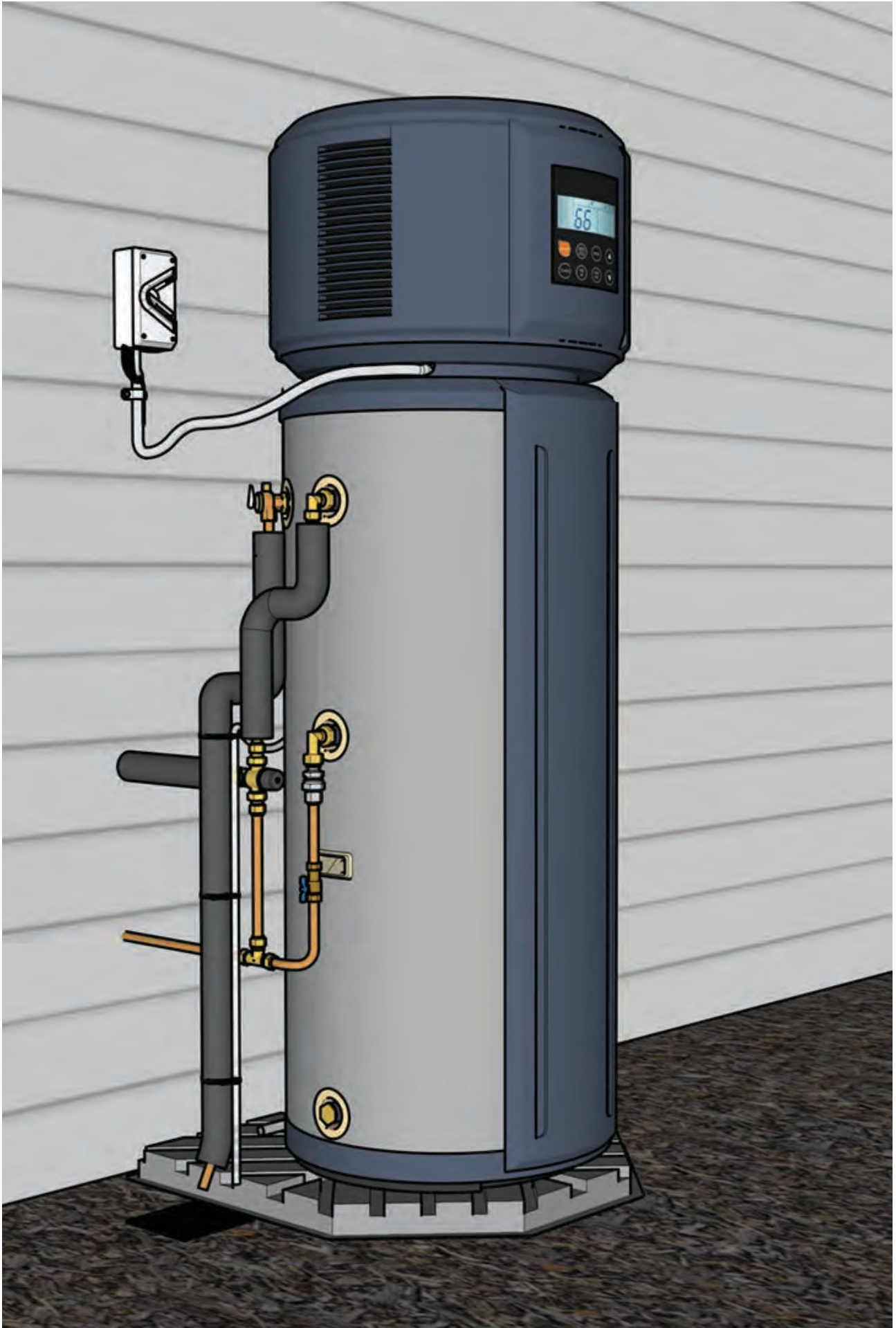

5 SYSTEM COMMISSIONING

5.1 Filling tank before operation

CAUTION

Operation without water in the tank may result in the damage of auxiliary e-heater (element). In case of such damage, the manufacturer will not be liable for any damages caused by this issue.



Before using this unit, please follow the steps below.

- Open the cold water inlet valve.
- Fill the unit with water by opening a hot water tap inside the home.
- Once water flows from the hot water tap, ensure all air in the system is bled then close the hot water tap.

5.2 Powering on the unit

CAUTION

Ensure that the tank is full of water and all air has been bled before turning on the power to the unit.

- Switch on the power to the water heater



- Unlock the control panel by pressing and holding the CANCEL button for 3 seconds
- Turn heater on by pressing the ON/OFF button on the control panel twice (Ensure the red LED is illuminated).
- Heater should then start running.



5.3 About Running

This heat pump unit has two kinds of heat sources: Heat Pump (compressor) and Electric heater (element).

The unit will automatically select the heat source/s to heat the stored water to the target temperature depending on the mode selected and the surrounding conditions.

NOTE

- There are different heat-up times at different ambient temperatures. Normally lower ambient temperature result in longer heat-up times because of lower effective performance.

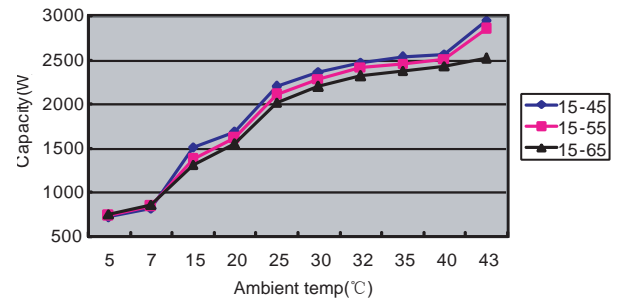

Ambient Temperature vs Capacity

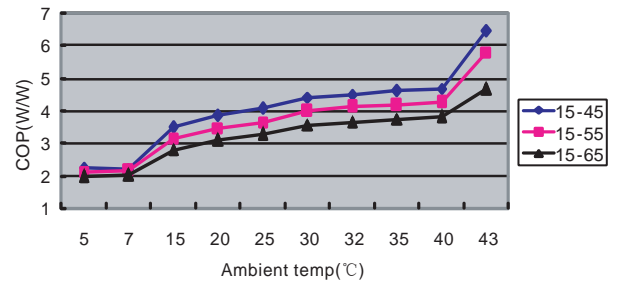

Ambient Temperature vs COP (Coefficient of Performance)

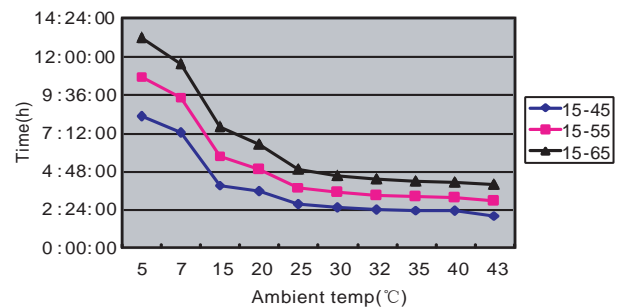

Ambient Temperature vs Time

- The temperature shown on the display depends on the water temperature sensor. It is normal that sometimes the display temperature decreases while the unit is running. This is caused when the natural convection of the upper hot water mixes with the lower cold water from inlet tap.
- If the system continuously reports heat pump protection, the latest error code and the alarm icon will be shown on the display. The heat pump will stop running and the unit will shift automatically to E-heater as the backup mode, but the error code and alarm icon will remain until power is reset.

5.4 Setting the mode

Operating mode should be selected manually. Refer to the below table for the modes of operation and the running temperature ranges & temperature limits:

Operation mode	Ambient temp. range	Setting temp. range	Max. temp. (Heat pump)
Economy	5°~43°	60°~65°	65°
Hybrid	-20°~43°	60°~70°	65°
E-heater	-20°~43°	60°~70°	-

Temperatures shown in Celsius

Hybrid mode is the recommended mode for best results.

NOTE

- The default heating source is heat pump. If the ambient temperature range is out of heat pump operating range, the heat pump will stop running and the unit will shift automatically to activate E-heater and show the icon LA on the display. Then if the ambient temperature increases back into the running range of heat pump again, E-heater will stop and shift automatically back to heat pump, and the icon LA will disappear from the display.
- If the target water temperature is higher than maximum temperature the heat pump can achieve, the unit will activate the heat pump mode firstly to heat the water as much as it can, before it stops and the E-heater is activated to continually heat the water to the target temperature.
- If only using E-heater mode, approx 60% of the tank water will be heated, so set a higher target water temperature if the ambient temperature is out of the heat pump running range.

5.5 Automatic functions

5.5.1 Defrosting during water-heating

- During the heat pump running period, if the evaporator becomes frosted due to low ambient temperatures, the system will defrost automatically to keep effective performance (about 5~15min). During defrosting mode, the compressor will stop, but the fan motor will continue to run.

5.5.2 TCO and ATCO

- The power of the compressor and E-heater will be automatically shut-off or turned on by the TCO (Thermal Cut-Out) and the ATCO (Automatic Thermal Cut-Out). If the water temperature is higher than 78°C, the ATCO will automatically shut off the power to the compressor and E-heater, and turn it on if the temperature falls below 68°C.
- If the water temperature is higher than 85°C, the TCO will automatically shut off the power to the compressor and the E-heater. This must then be reset by an authorised service technician.

5.5.3 Automatic E-Heat mode in cold temperatures

- When ambient temperatures are below 5°C, the heat pump efficiency decreases dramatically. During this time the unit will automatically shift to E-heater mode.

5.5.4 Protection Mode

- When the self-protection mode activates, the system will be stopped and start a self-check. Once the error is resolved the unit will restart.
- When the self-protection mode activates, a beep will sound every second minute and the alarm icon will flash and error code will be displayed on screen. Press the cancel button for 1 second to stop the beep, however the alarm icon will continue to be displayed on screen until the error is resolved.
- The unit may enter self-protection mode for a number of circumstances including but not limited to:
 - A blocked air inlet or outlet;
 - The evaporator is covered with too much dust;
 - The unit is receiving incorrect power supply (exceeding the range of 220-240V).







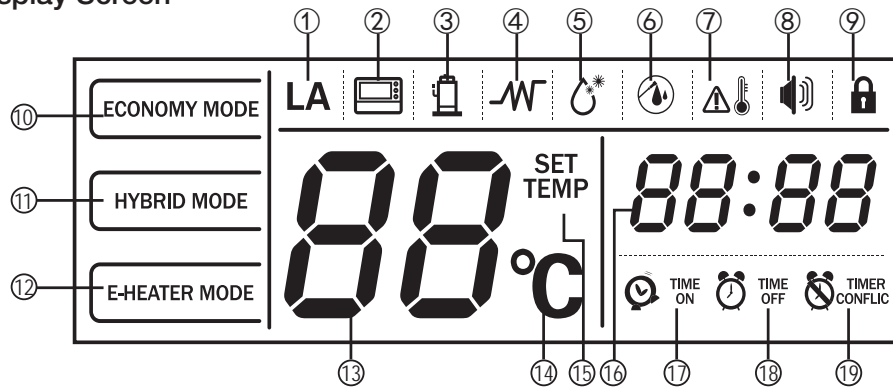

5.5.5 Error Mode

- In the case of an error occurring, the unit will automatically shift to E-heater for emergency hot water supply.
- In the case of a serious error, the unit will not start.
- For some errors, a beep will sound 3 times every minute and the alarm icon will flash. Press the cancel button for 1 second to stop the beep, however the alarm icon will continue to be displayed on screen until the error is resolved.
- For all errors please contact an authorised technician.

6 | SYSTEM OPERATION

6.1 Display Screen



<p>1</p> 	<p>Ambient temperature outside the operational range of the heat pump:</p> <p>If the ambient temperature is outside the operating range of the heat pump function, the LA icon will be displayed on screen</p>
<p>2</p> 	<p>Wired controller (reserved function):</p> <p>If a wired controller is connected to the unit then the Wired Controller icon will be displayed on screen</p>
<p>3</p> 	<p>Compressor:</p> <p>If the compressor is activated, the Compressor icon will be displayed on screen</p>
<p>4</p> 	<p>E-heater:</p> <p>If the heating element is activated, the E-heater icon will be displayed on screen</p>
<p>5</p> 	<p>Disinfection:</p> <p>When the unit is in disinfection mode, the Disinfection icon will be displayed on screen</p>
<p>6</p> 	<p>Fill water:</p> <p>When the unit is first powered on (or after the unit is re-powered and the unit was not operational at the time the power was turned off) the flashing fill water icon will be displayed on screen indicating to fill tank before making it operational. Once the tank is full, simply unlock the control panel and press the ON/OFF button (changing the flashing fill water icon to a solid icon). Pressing the ON/OFF button once again will turn the icon off.</p> <p><i>Note: The fill water icon, will not be displayed when the unit is re-powered and the unit was operation at the time the power was turned off).</i></p>
<p>7</p> 	<p>High temp:</p> <p>If the target water temperature exceeds 50°C then the High Temp icon will be displayed on screen</p>
<p>8</p> 	<p>Alarm:</p> <p>If the unit is experiencing an error or has gone into protection mode, the flashing Alarm icon will be displayed on screen along with a series of beeps that will sound 3 times every minute until the protection/error is resolved or cancelled (by pressing and holding the CANCEL button for 1 second)</p>

9		<p>Lock:</p> <p>If the control panel is in a locked state, the Lock icon will be displayed on screen</p>
10		<p>Economy mode:</p> <p>If the unit is operating in economy mode, the Economy Mode icon will be displayed on screen. When selecting mode, the icon will flash if economy mode is selected.</p>
11		<p>Hybrid mode:</p> <p>If the unit is operating in hybrid mode, the Hybrid Mode icon will be displayed on screen. When selecting mode, the icon will flash if hybrid mode is selected.</p>
12		<p>E-heater mode:</p> <p>If the unit is operating in e-heater mode, the E-heater Mode icon will be displayed on screen. When selecting mode, the icon will flash if e-heater mode is selected.</p>
13		<p>Water temperature setting</p> <p>When the control panel is not in operation the water temperature setting will display the current water temperature in the tank; When setting the desired temperature the water temperature setting will display the desired temperature; When in error or protection mode the water temperature setting will display the relevant code; When in query mode, the water temperature setting will display the relevant running parameter.</p>
14		<p>Temp-unit</p> <p>When the Water temperature setting is displaying a temperature the Degrees Celsius icon will be displayed on screen.</p>
15		<p>Set Temp</p> <p>When setting the units desired temperature, the Set Temp icon will be displayed on screen.</p>
16		<p>Clock</p> <p>The clock will be displayed all the time. When in clock setting mode, the clock will show the setting time, outside of this mode the clock will display the current set time.</p>
17		<p>Time on</p> <p>If a TIME ON timer has been set, the TIME ON icon will be displayed on screen.</p>
18		<p>Time off</p> <p>If a TIME OFF timer has been set, the TIME OFF icon will be displayed on screen.</p>
19		<p>Timer conflict (reserved function)</p> <p>If a wired controller is connected to the unit and the timer which has been set on the control panel is not the same as the timer set on the wired controller, then the TIMER CONFLICT icon will display on screen.</p>

6.2 Control Panel

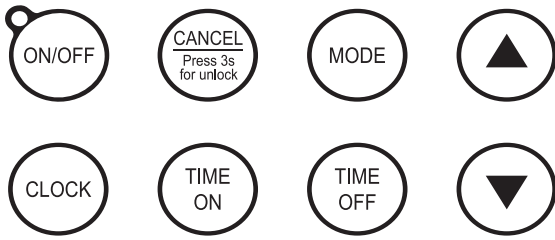

Before performing any functions on the control panel it needs to be unlocked. To unlock the control panel, press & hold the CANCEL button for 3 seconds. The controller screen can be illuminated by pressing any button. An illuminated screen does not mean the control panel is unlocked or that the unit is running. The LED to the top left of the ON/OFF button must be illuminated for the unit to operate. The screen back light will automatically turn off after 30 seconds of no operation.



Unlocking the control panel

To avoid unintentional changes to the unit, the control panel is fitted with a special automatic lock. The automatic lock is activated after there is no operation for 1 minute. The screen will display a lock icon  on the top right of the screen when the unit is locked.

- To unlock the control panel, press & hold the cancel button for 3 seconds. Once unlocked all functions of the control panel are now available.



Turning the unit ON

Before turning the unit on, please ensure the tank is full of water

- To turn the unit ON, unlock the control panel and proceed to press the ON/OFF button.
- Check that the LED light to the top left of the ON/OFF button is illuminated. The unit is on and operational when the LED light is illuminated. If the LED is not illuminated then the unit is not operational.



Turning the unit OFF

- To turn the unit OFF, unlock the control panel and proceed to press the ON/OFF button.
- Check that the LED light to the top left of the ON/OFF button is no longer illuminated.



Selecting / Changing the desired MODE

- To select / change the desired MODE, unlock the control panel and proceed to press the MODE button.
- Continue to press the MODE button until the desired mode is selected on the screen. The unit can operate in the three modes: Economy Mode, Hybrid Mode and E-heater Mode. Hybrid mode is the recommended mode for best results. Refer to page 10 for further explanation of the three modes.



Increase / Up

- To increase the temperature, unlock the control panel and proceed to press the UP ARROW button.
- When setting the clock / timer, to increase the time press the UP ARROW button.



Decrease / Down

- To decrease the temperature, unlock the control panel and proceed to press the DOWN ARROW button.
- When setting the clock / timer, to decrease the time press the DOWN ARROW button.



Setting the 24 Hour Clock

If the intention is to use timers with the unit, the initial clock time will need to be set.

- To set the current time, unlock the control panel and proceed to press the CLOCK button. The hour value will flash
- Use the ARROW buttons to set the correct hour value.
- Press the CLOCK button again to confirm hour setting. The minute value will flash
- Use the ARROW buttons to set the correct minute value.
- Finally press the CLOCK button again to confirm the minute setting.

(please note if there is no operation for 10 seconds the unit will automatically confirm the clock setting)

Note: In the event the power to the unit is switched off (i.e brownout), the clock will reset to 00:00. Please note if timers are used, the clock will need to be reset to the correct time to ensure the timers do not adversely affect the operation. If the power is switched off while the unit is not on, once the power resumes the unit will revert back to the previous status (off) and will remain off.



Setting the TIME ON Timer

If the Timer is set to TIME ON, the unit will automatically operate once between the setting of the clock and the last 24 hours.

- To set the TIME ON value, unlock the control panel and proceed to press the TIME ON button.
The TIME ON clock will appear below the normal clock with the hour value flashing
- Use the ARROW buttons to set the correct hour value.
- Press the TIME ON button again to confirm hour setting.
The minute value will flash
- Use the ARROW buttons to set the correct minute value in 10 minute increments.
- Press the TIME ON button again to confirm minute setting.
(Please note if there is no operation for 10 seconds the unit will automatically confirm the clock setting)



Setting the TIME ON & TIME OFF Timer

If a Timer is set to TIME ON & TIME OFF, the unit will automatically operate between the setting TIME ON & TIME OFF clock. If the TIME OFF clock is set to the same TIME ON clock then the TIME OFF clock will automatically be delayed by 10 minutes.

- To set the TIME ON value, unlock the control panel and proceed to press the TIME ON button.
The TIME ON clock will appear below the normal clock with the hour value flashing
 - Use the ARROW buttons to set the correct hour value.
 - Press the TIME ON button again to confirm hour setting.
The minute value will flash
 - Use the ARROW buttons to set the correct minute value in 10 minute increments.
 - Press the TIME ON button again to confirm minute & TIME ON setting.
 - To set the TIME OFF value, press the TIME OFF button.
The TIME OFF clock will appear below the normal clock to the right of the TIME ON clock with the hour value flashing
 - Use the ARROW buttons to set the correct hour value.
 - Press the TIME OFF button again to confirm hour setting.
The minute value will flash
 - Use the ARROW buttons to set the correct minute value in 10 minute increments.
 - Press the TIME OFF button again to confirm minute setting.
(Please note if there is no operation for 10 seconds the unit will automatically confirm the clock setting)
- Note: TIME OFF function is only available when a TIME ON function has been set*



Cancelling the Timers (TIME ON / TIME OFF)

- To cancel timers, unlock the control panel and then proceed to press the CANCEL button for 3 seconds.

6.3 Button Combination Functions

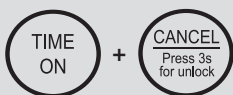

Clear Error Code

- To clear the error code, unlock the control panel and then proceed to press both the TIME ON & CANCEL buttons at the same time to clear all stored error & protection codes.
The beep will sound one time.



Enter Query Mode

Query Mode allows for the checking of the units settings & running parameters

- To enter Query Mode, unlock the control panel and then proceed to press both the CLOCK & CANCEL buttons at the same time for 1 second.
- Press the UP or DOWN ARROW buttons to scroll through the values.
- To exit Query Mode, press the CANCEL button for 1s.
(Please note if there is no operation for 30 seconds the unit will automatically exit Query Mode)

7 | SYSTEM TROUBLESHOOTING

7.1 General Troubleshooting

7.1.1 How do I know the unit is working

Check that the LED light next to the on/off button is on. If this light is not lit, then the system is not operating. Simply press & hold the cancel button for 3 seconds (unlock the controller) then press the on/off button to turn the unit on and check that the LED light is lit.



7.1.2 Water from the heat pump is not hot enough

If you find your heat pump is not supplying hot water then this is most likely related to one of the following:

1. Hot water has been largely consumed and the system needs to reheat the replenished water.

Check the temperature on the unit and then leave for an hour and see if this has increased.
(Please note if the system has been completely emptied recovery may take up to 4 - 5 hours)



2. A timer might be incorrectly set turning the unit off at the wrong time.

If your screen is showing the 'time on' or 'time off' icon then it appears a timer has been set. When timers are set this turns the unit on and off at the set time periods. Remove all timers, by holding the cancel button for 3 seconds to unlock the controller, then press the time on or time off buttons, proceeded by the cancel button to wipe the timers. Should you wish to set timers for your system please refer to section 6 of this guide on how to do so.



3. The unit has been switched off.

Check the unit and ensure the red LED light is showing. If not, unlock the controller by holding the cancel button for 3 seconds (the lock icon will disappear from the display screen). Then simply press the on/off button and now the red LED light should be lit.



4. The connected power is still in off peak supply only.

We recommend that power is available to the unit 24/7. This ensures that the unit can work to its maximum efficiency. If your water is not hot enough and only off peak power is supplied to the unit then the system cannot operate until the off peak period is active. If you believe your system is only available during off peak supply please contact our service team for further assistance.

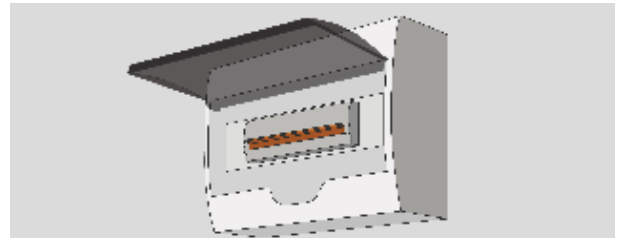

5. There may be an issue between the heat pump unit and the hot water outlet.

Check the controller for the in tank temperature. If the controller is indicating the tank is at or near the set temperature then locate the PTR valve on the left hand side of the unit. Carefully release the PTR valve to release water directly from the tank.

NOTE: Water expelled may be extremely hot.

Carefully check if the water released is hot. If water is hot, then there appears to be an issue beyond the heat pump unit. If so, please contact your plumber or our service team for further assistance.



7.1.3 It appears water is leaking from the unit.

The unit is fitted with a condensate release point at the lower section of the head unit towards the rear of the system. At time of installation a condensate drain pipe should have been connected to this point. Check the area where the leak is occurring to see if this is coming from the condensate drain pipe. If not and water appears to be leaking from a different section of the heat pump unit, please contact our service team for further assistance.

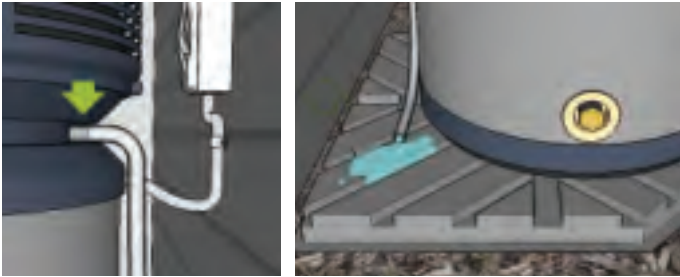

7.1.4 None of the buttons on the controller work

Chances are the controller is in its locked state. Simply press and hold the Cancel / Unlock button for 3 seconds to unlock the controller. Now all the buttons will be functional.



7.1.5 It appears unit is set to a low temperature (i.e. below 50°C)

The temperature shown on the controller is showing the current temperature in the tank and not the set temperature. To check the set temperature unlock the unit by pressing the unlock button for 3 seconds and simply press either the up or down button to check the set temperature.



7.1.6 Unit is outside a bedroom & the noise is too much during the night

If the location of your heat pump unit is in close proximity to a bedroom and your hot water usage pattern is consistently high at night then the heat pump may operate during the night. During the quietness of night you may hear the quiet hum of the heat pump that may cause you some concern. If your hot water usage pattern is consistently high at night and the noise is a concern, you may need to set a timer that will in effect turn the unit off during the night. Note: if a timer is set the heat pump will only operate during the set period. Please note, if large amounts of hot water are consumed outside this set period or near the end of the set period, the system will not be able to bring the water back up to temperature until the set period kicks in. For instruction on setting timers, please refer to section 6 of this guide for further details or contact our service team for further assistance.



7.1.7 System shows P or E code on controller.

If the controller on your system is presenting with a 'P' or 'E' code followed by a number, then this is highlighting an error or protection function within the system. Please refer to the following table (over page) for further details or contact our service team for further assistance.



7.2 Error Codes

Display	Malfunction Description	Corrective Action
E1	Error of sensor T5L (lower water temperature sensor)	The connection between sensor and PCB is broken or the sensor has experienced an issue. Contact a qualified person to service the unit.
E2	Tank and wired controller communication error	The connection between controller and PCB is broken or the PCB has experienced an issue. Contact a qualified person to service the unit.
E4	Evaporator temperature sensor T3 error	The connection between sensor and PCB is broken or the sensor has experienced an issue. Contact a qualified person to service the unit.
E5	Ambient temperature sensor T4 error	The connection between sensor and PCB is broken or the sensor has experienced an issue. Contact a qualified person to service the unit.
E6	Compressor discharge temperature sensor TP error	The connection between sensor and PCB is broken or the sensor has experienced an issue. Contact a qualified person to service the unit.
E8	Electric leakage error If PCB current_induction_circuit check the current difference between L,N >14mA, system consider it as "electric leakage error"	The connection between some wires have broken or there is a wiring connection issue. Contact a qualified person to service the unit.
E9	Compressor suction temperature sensor TH error	The connection between sensor and PCB is broken or the sensor has experienced an issue. Contact a qualified person to service the unit.
P8	E-heater open-circuit protection (IEH(Current difference E-heater on & e-heater off)<1A)	The E-heater has been broken or there is a wiring connection issue. Contact a qualified person to service the unit.
P2	High discharge temperature protection Tp>115°C, Protection active Tp<90°C, Protection inactive	System is potentially blocked, air or water or low refrigerant (leakage) in system or water temp sensor malfunction. Contact a qualified person to service the unit.
P4	Compressor overloaded protection (10 seconds after compressor start up), Current checking starts, 1. Only when compressor is running, if it is >7A , the compressor will stop for protection. 2. Compressor + e-heater open, if it is >IEH+7,the compressor will stop for protection.	Compressor broken, system blocked, air or water or too much refrigerant in system or water temperature sensor malfunction. Contact a qualified person to service the unit.
LA	When the ambient temp T4 is out of Heat Pump running range (5 ~ 43°) Heat Pump will stop, unit will show LA on the position of clock on display until T4 back to (5 ~ 43°)	It is normal, and repair is not necessary.

NOTE

The diagnostic codes listed above are the most common. If a diagnostic code not listed above is displayed, please contact for technical assistance.

8 | SYSTEM MAINTENANCE

8.1 Cleaning the air filter

(Frequency: Every Month)

- Turn off the power to the unit.
- Remove top cover by releasing the locking screw and rotating in a clockwise direction.
- Slide the air filter out by lifting directly up.
- Clean filter accordingly and refit in the reverse manner.

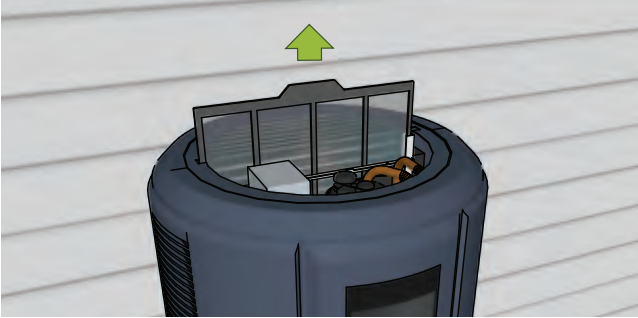

8.2 Checking the anode & replacing if required

(Frequency: Every Half Year - Replace if required)

The anode protects the inner lining of your hot water tank. When the anode becomes degraded the level of protection is diminished. It is recommended that the anode is periodically checked for its level of degradation and gets replaced if required.

- Turn off the power, and turn off the cold water inlet valve.
- Open a hot water tap, and decrease the pressure of the inner container.
- Open the drain port, and release about 20 litres of water.
- Remove the top cover by removing the locking screw and rotating in a clockwise direction.
- Release the front casing, disconnect the display cable from the electrical compartment and put aside.
- Locate the anode position on the left hand side.
- Remove the anode cover by releasing the two screws.
- Unscrew the anode and lift directly up.
- Check for degradation.
 - If still in suitable condition, refit ensuring an effective seal.
 - If anode is in an unsuitable condition, replace with a new one, ensuring an effective seal.
- Re open the cold water inlet valve.
- Open a hot water tap until hot water flows out, then turn off the hot water tap.
- Turn on the power to restart the unit.
- Now the unit can be used as normal.

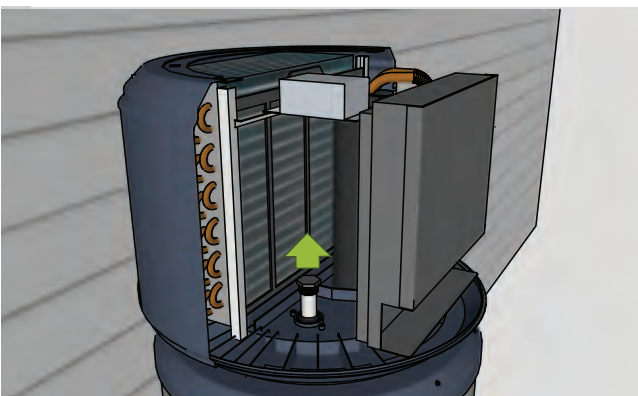

8.3 Cleaning the inner tank and E-Heater

(Frequency: Every Half Year)

It is recommended to clean the inner tank and E-Heater regularly to maintain efficient performance.

- Turn off the power.
- Close the cold water inlet valve & open a hot water tap.
- Use a flexible pipe to connect the drain port to a suitable sewage drain. (Note: The min. heat resistance of the drain pipe must not be less than 93°, if the drain pipe does not meet the requirement, please open the cold water inlet valve & open a hot water tap, until the temperature of the water is suitable for the drain pipe).
- Open the drain port of the water heater; drain out all the water in the inner tank. If it is needed, use water to wash the inner tank several times to clear the deposits.
- Close the drain port, re-fill the inner tank with water, and turn the power back on.

8.4 Operating the PTR valve

(Frequency: Every Half Year - Replace if required)

It is recommended to operate the PTR valve periodically to ensure water flows freely. If water doesn't flow freely, the PTR valve will need to be replaced.

- Locate the PTR valve on the left hand side of the unit.
- Carefully release the valve using the lever & release some water from the tank.
NOTE: Water expelled may be extremely hot.
- If water flows freely the PTR appears to still be in a suitable working condition.
- If water does not flow freely it would appear the PTR valve is due for replacement.
- If the PTR valve needs replacing, please contact your plumber or our service team for further assistance.



8.5 Other maintenance checks

1. Regularly check the electrical wiring for any damage and contact our service team or your electrician if damage is evident.
2. In some cold areas (below 0°), if the system will be stopped for a long time, all the water in the tank should be released and the tank refilled prior to reuse in case freezing has occurred inside the inner tank. Failure to do this may result in severe damage to the heating element.

9 | HEAT PUMP WARRANTY

The warranty applies to Midea heat pumps installed in a single family dwelling only and is provided only to those acquiring the heat pump as consumers within the meaning of the Australian Consumer Law. The terms of the warranty are effective from the date the heat pump is installed. The validity of the product warranty period may be verified by requesting a copy of the certificate of compliance that accompanied the installation. A compliance certificate is mandatory in all Australian states and territories.

9.1 Warranty period

1. This warranty warrants that the following heat pump components will remain free of defects for the specified periods from the date of installation:
 - Tank Cylinder - 5 years product / 3 years labour.
 - Compressor - 3 years product / 1 year labour.
 - All other components supplied, including valves, elements, thermostats and sacrificial anodes - 1 year.
2. No warranty is given in relation to components not supplied, for example tempering valves and cold water valve assemblies used by installers.
3. Subject to the conditions and exclusions specified in this warranty, the owner may have the defective heat pump component repaired or replaced covered under this warranty as soon as reasonably practicable after the consumer has reported the defect.

9.2 Consumers to register the warranty

For efficient processing of making a claim under this warranty, consumers are encouraged to complete all details on the following warranty form and send it to the address indicated on the form. Alternatively warranty can be registered via the web address indicated on the form.

9.3 Procedure to make a claim under warranty

Upon discovering a suspected defect, consumers should immediately report the suspected defect:

- To the installer or supplier, if the suspected defect arises as a result of the installation of the heat pump or relates to any components not covered by this warranty.
- To Chromagen on the phone number below during the relevant warranty period, if the suspected defect relates to any components covered by this warranty.

Please Note: To successfully make a warranty claim, Chromagen must be advised of the Heat Pumps serial number.

Failure to advise serial number, may delay the service request and or prevent the service request from being processed.

9.4 Specific exclusions

To the extent permitted by law Chromagen does not accept liability under this warranty:

- If any component of the heat pump has been installed, repaired, repositioned or modified by a person other than an appropriately qualified person approved by Chromagen in accordance with the installation and maintenance instructions and relevant local and statutory requirements;
- For loss or damage caused by a fault or defect in the installation of the heat pump;
- If corrosion has occurred because the anode has not been changed in accordance with the installation & maintenance guide;

- If a cold water expansion valve, check valve and strainer is not fitted in areas where mains pressure is likely to exceed 500kPa;
- For any damage arising as a result of an accident, act of God or other circumstances beyond Chromagen's control;
- If the inner cylinder has collapsed as a result of an incorrect filling and/or commissioning procedure;
- For components not supplied by Chromagen that are used in the installation of the heat pump water heater e.g. tempering valves, cold water valve assemblies, etc.
- For extended or implied warranties not formally provided by Chromagen;
- For external labour or equipment costs (e.g. cranes and lifting devices) required for repairs;
- For costs incurred for rectifying faults (or perceived faults) not directly attributed to the heat pump water heater;
- For travel costs of service agents that exceed 30 kilometres;
- For all consequential loss or damage arising from defects that can lawfully be excluded;
- For any other issues not directly attributable to defects in components supplied by Chromagen including:
 - (a) Damage caused by incorrect commissioning;
 - (b) Leakage from valves not supplied by Chromagen;
 - (c) Leakage from the pressure temperature relief valve where the water pressure or temperature exceeds the limits specified in the installation and maintenance instructions;
 - (d) Water hammer;
 - (e) External rust on the storage tank;
 - (f) Insufficient hot water because:
 - (i) the consumer refuses to use the auxiliary booster;
 - (ii) of an incorrectly set or faulty tempering or mixing valve;
 - (iii) of faulty or incomplete installation;
 - (iv) the water heater is too small for its required purpose;
 - (v) of insufficient water flow as a result of "water saving" tap-ware or appliances;
 - (vi) of blown fuses, "tripped" electrical switches or inadequate household electrical wiring;
 - (vii) insufficient water flow caused by debris accumulating in water strainer.

9.5 Important Note

The benefits conferred by this warranty are in addition to any other rights and remedies available to the consumer under a law in relation to the goods or services to which the warranty relates.



Another Hot Water Solution by 
ChromagenTM
Solar & Energy Solutions

chromagen.com.au | 1300 367 565

Hot Water Solutions | Solar Power Systems | Kitchen Appliances | Air Conditioning

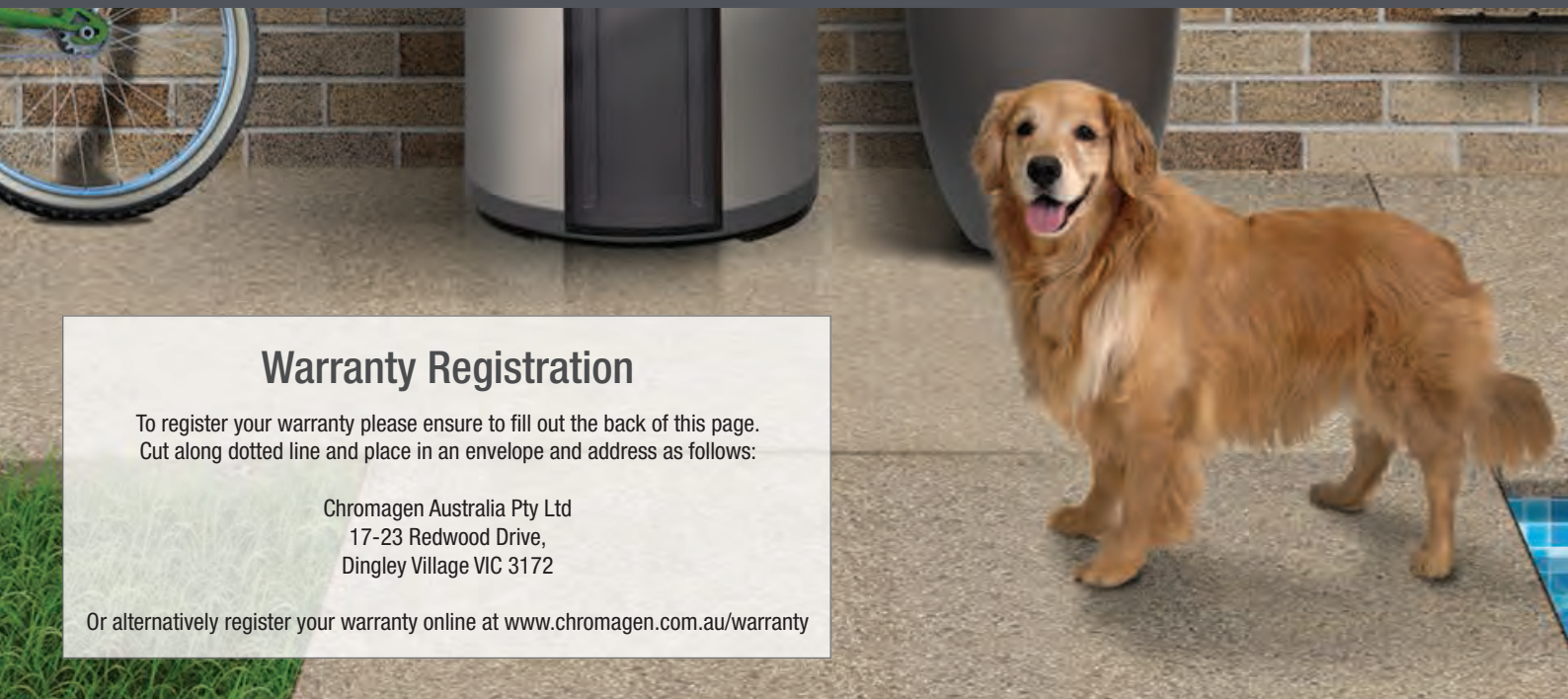

Warranty Registration

To register your warranty please ensure to fill out the back of this page.
Cut along dotted line and place in an envelope and address as follows:

Chromagen Australia Pty Ltd
17-23 Redwood Drive,
Dingley Village VIC 3172

Or alternatively register your warranty online at www.chromagen.com.au/warranty